

# VIS À VIS



## DESIGNER

Piergiorgio Cazzaniga

## DESCRIPTION

The chairs of the Vis à vis collection all combine ergonomic seating comfort with a natural look. Check out the rounded corners of the teak frame and the airy Canax® weave in one continuing flowing line from the seat to the back. The weather-proof Canax® straps are made with natural hemp and give these chairs a very natural, harmonious look.

The lounge on the other hand, has an integrated tabletop, made of square slats and is designed in a way that two sunbeds fit into each other. Thanks to the flexible bed base, you can lie either next to each other or opposite each other.

## MATERIALS

- Frame : plantation teak from East-Java, every part is handpicked during the cutting process of the tree
- Seat & back : plaited Canax® straps (polyester coated with a mix of solution dyed PVC and natural hemp). UV-, rot and mildew resistant.
- Hardware : 316L electropolished stainless steel
- Table : tables with a length of more than 300cm consist of 99x99cm tabletops that are attached to each other with 304L powdercoated stainless steel support bars

## COLOURS STRAPS

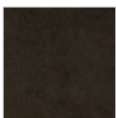

Earthbrown

**TRIBÙ**  
The art of leisure

## TECHNICAL DRAWINGS\*

### 01718 - Armchair

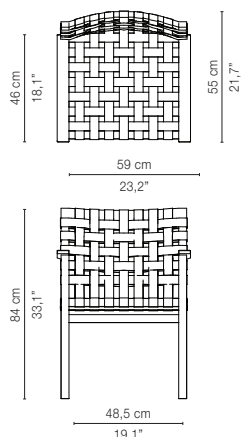

9,15 kg  
 delivery unit: 1  
 packaging:  
 60 x 62 x H87,5 cm - 0,32 m<sup>3</sup>  
 10,20 kg

### 01740 - Adjustable lounger

### 01741 - Adjustable lounger with 2 wheels

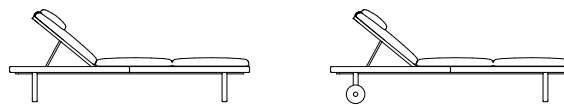

01740

01741

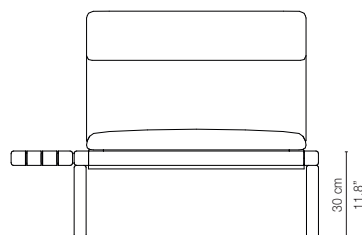

41,80 kg  
 delivery unit: 1  
 packaging:  
 240 x 112 x H8,5 cm - 0,23 m<sup>3</sup>  
 43,65 kg

### 01712 - Clubchair

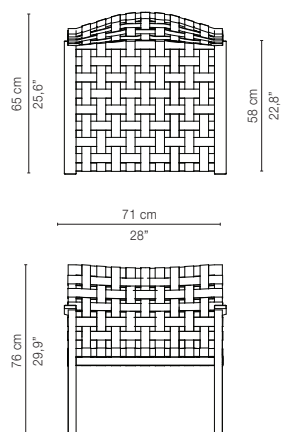

10,15 kg  
 delivery unit: 1  
 packaging:  
 73,5 x 73,5 x H79,5 cm - 0,43 m<sup>3</sup>  
 11,25 kg

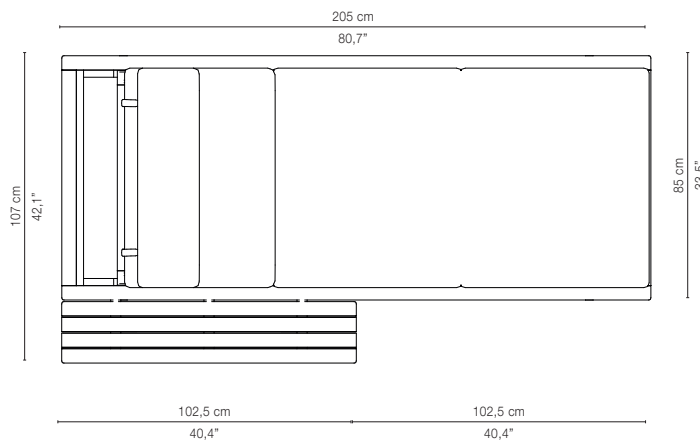

### option : 01740W - set of 2 wheels

2,70 kg  
 delivery unit: 1  
 packaging:  
 28 x 26,5 x H15,5 cm - 0,01 m<sup>3</sup>  
 3,20 kg

### 01713 - Rocking chair

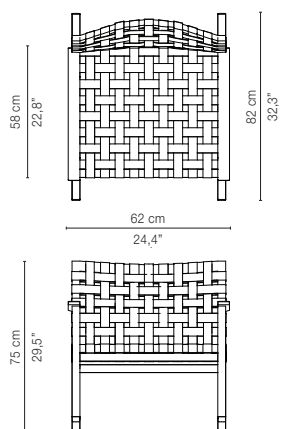

10,35 kg  
 delivery unit: 1  
 packaging:  
 83 x 64 x H79 cm - 0,42 m<sup>3</sup>  
 11,50 kg

\* The cushions on the drawings are not included in the article.  
 Appearances, measurements and weights may slightly differ from reality.

## TECHNICAL DRAWINGS\*

### Legend:

packaging A:  
table top  
33,05 kg  
103 x 102 x H7,5 cm - 0,08 m<sup>3</sup>

packaging B:  
set of legs  
8,70 kg  
76,5 x 59 x H13 cm - 0,06 m<sup>3</sup>

packaging C:  
set of support profiles  
21,7 kg  
165,5 x 15 x 11cm - 0,03 m<sup>3</sup>

packaging D:  
set of extension profiles  
9,8 kg  
122 x 15 x 6,5cm - 0,01 m<sup>3</sup>

### 01773 - Table 99cm

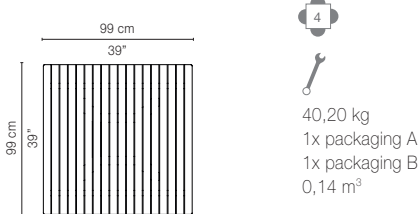

### 01753 - Table 300cm

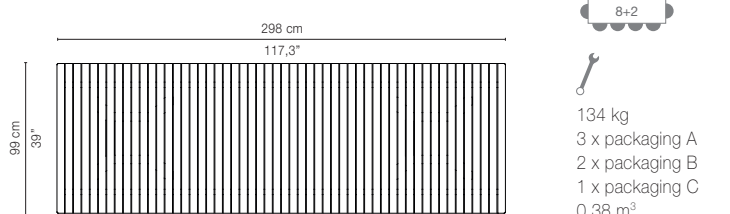

### 01754 - Table 400cm

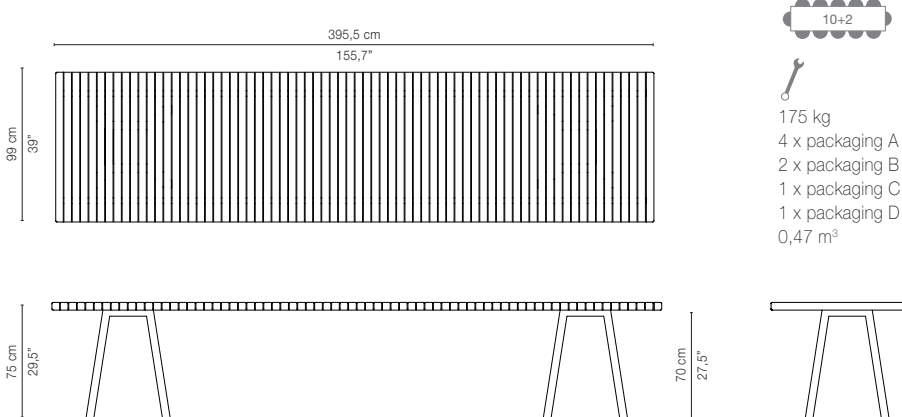

From a length of 5 m or more a third set of legs will be added

### 01755 - Table 500cm/197"

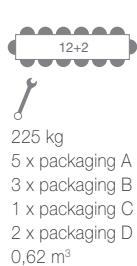

### 01756 - Table 600cm/236"

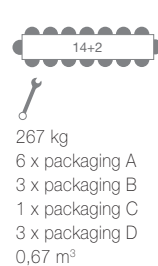

### 01757 - Table 700cm/275"

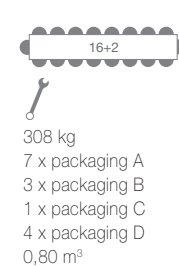

# VIS À VIS

## CUSHIONS

Armchair :	C01718 Cat A-B-C
Clubchair :	C01716 + lumbar cushion C01716B Cat A-B-C
Rocking chair :	C01717 + lumbar cushion C01717B Cat A-B-C
Lounger :	C01740W Cat D-E

Cat A-B-C= standard filling  
(polyurethane foam)  
Cat D-E= outdoor filling  
(water-repellent)



## PROTECTION COVERS

Covers in waterproof, PU-breathable material are available for each item. Colour grey.

## MAINTENANCE

Treat new teak with Teak Protector 4 to 6 weeks after installation. Teak Protector applies an invisible film and prevents stains and the growth of moss. Dirty teak can be cleaned with Teak Cleaner (regular cleaning) or Teak Super Cleaner (intense cleaning). Leave the furniture to dry completely and then apply Teak Protector. Rough wood can be sanded slightly before applying the Teak Protector. The Canax straps can be cleaned with soap and water or with Synthetic Super Cleaner. Rinse thoroughly with clear water.

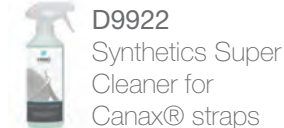
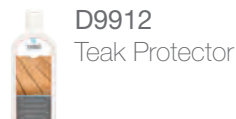
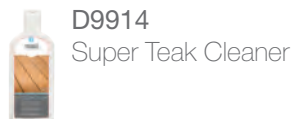
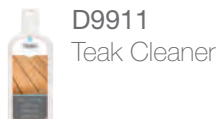



# VIS À VIS SOFA

## PROJECT REFERENCES

---

Ibiza Gran Hotel – Ibiza

